

# INSTALLATION GUIDE

Part #8800-1170 Rev. 1.0  
Spring 2009

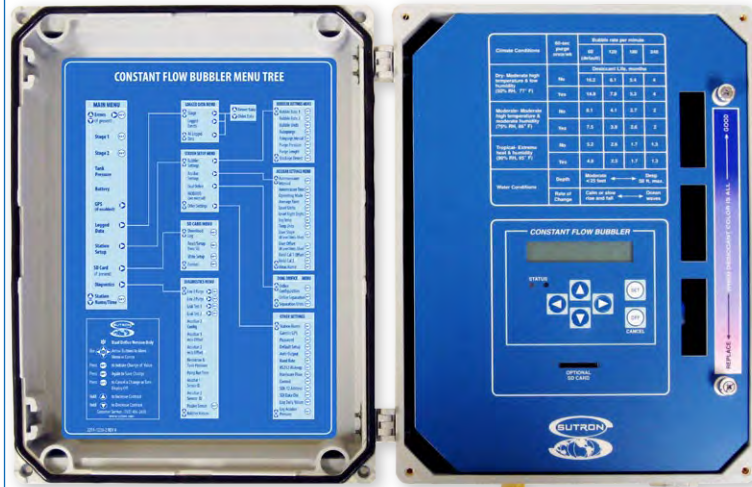

**SUTRON CORPORATION**  
www.sutron.com  
(703)406-2800  
22400 Davis Drive  
STERLING, VA 20166

The Sutron Constant Flow Bubbler is set at the factory to record water levels in feet every 15 minutes. This guide provides:

- Important tips for installing the Bubbler
- Instructions for using the Constant Flow Bubbler with a Sutron Satlink GOES Transmitter/Logger

Advanced settings in the bubbler allow it to operate as a stand-alone water level logger. Bubble rates, purge intervals, and other parameters may be modified for special situations such as rapid level changes or heavy sedimentation around the bubbler orifice.

Consult the Operations and Maintenance Manual for information on how to recover your data and how to change the default settings.

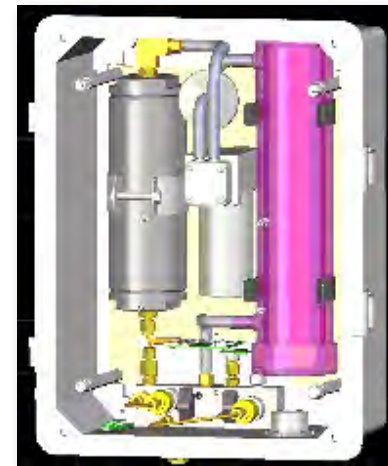

## STEP 1 LOCATE REQUIRED PARTS



## STEP 2 INSTALLATION DESIGN

Do you need anything at the end of the bubbler line? Unless you are measuring the level in a well or tank, the answer is probably yes. Stream velocity at the bubbler line termination can and will affect the measured level.

The termination must be exposed only to "static" pressure and not to dynamic pressure caused by the flowing water. Studies by USGS have shown that depth errors of as much as 0.84 meters (2 3/4 feet) are possible in fast moving streams (15 ft/second). "Naked" terminations, as shown here, should only be used in stilling wells, ponded or slow moving water, or reservoirs.

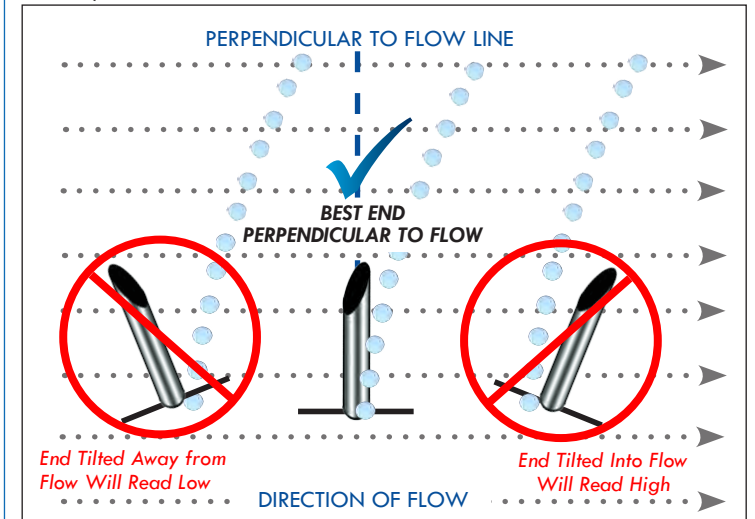

## STEP 3 ORIFICE OPTIONS

There is no single correct type. Those pictured here are typical designs used by various agencies and manufacturers.

Use #1 Configuration at very low velocities or in reservoirs and stilling wells (Rickly USGS configuration).

Use #2 (USGS 9330), #3 (National Ocean Service), or #4 (High Sierra 6695) where bubbler termination is suspended in flowing water.

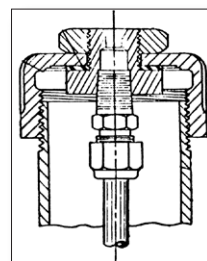

#1

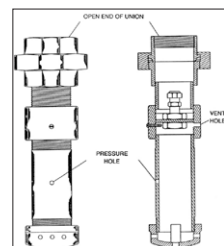

#2

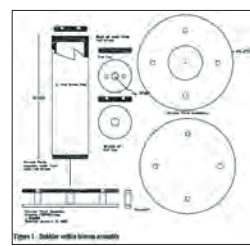

#3

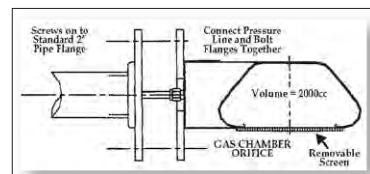

#4

## STEP 4

INSTALL THE ORIFICE & STATIC TUBE CORRECTLY (IF USED)

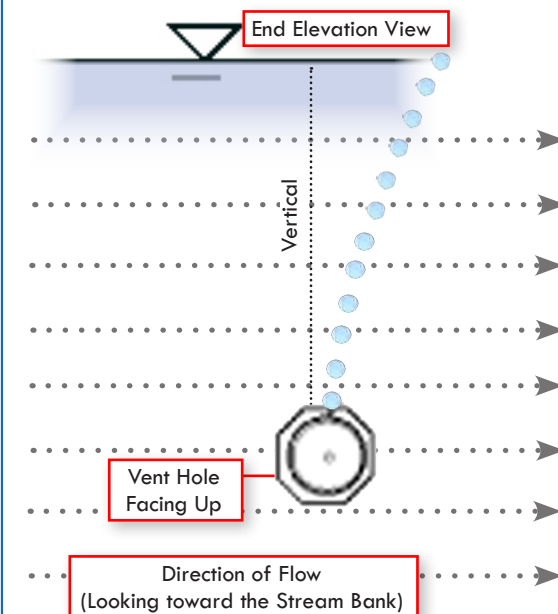

INSTALL THE STATIC TUBE PERPENDICULAR TO THE DIRECTION OF FLOW.

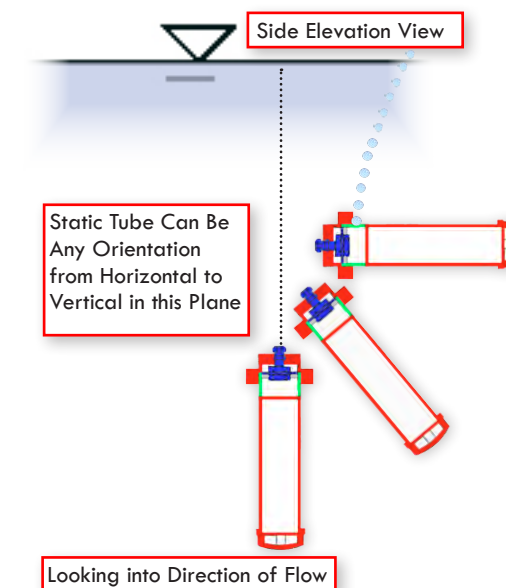

STATIC TUBE AXIS SHOULD BE PERPENDICULAR TO FLOW LINES

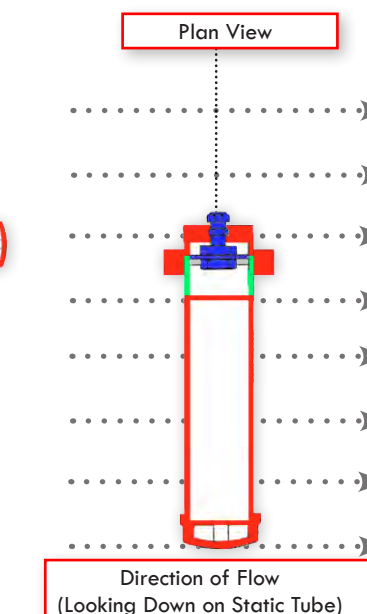

## STEP 5 CORRECTLY INSTALL BUBBLER & ORIFICE LINE.

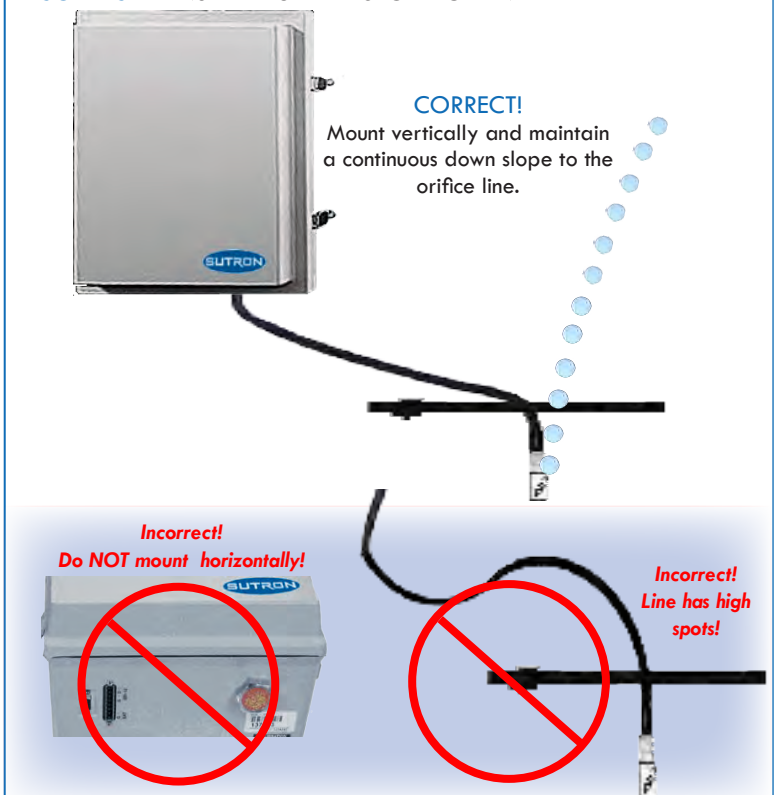

CONSTANT FLOW BUBBLER/RECORDER

STEP 6  
PROTECT THE ORIFICE PRESSURE LINE.

Protect orifice line from water-borne debris & foot traffic. Use a heavy-walled line &/or protect the line by running it in PVC conduit or metal pipe.

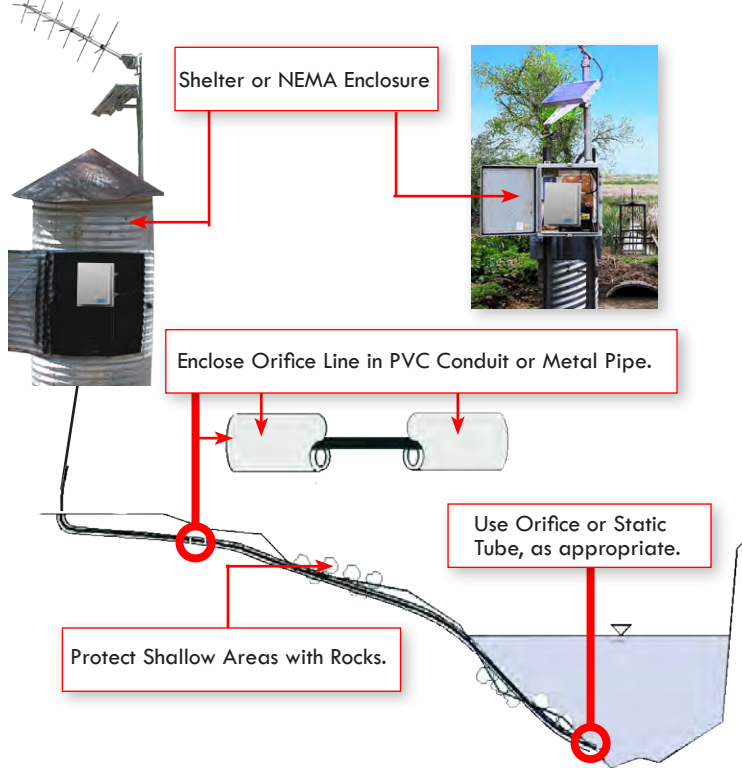

CONSTANT FLOW BUBBLER/RECORDER

STEP 7  
CONNECT POWER TO THE BUBBLER

NOTE: The power connector is removable.

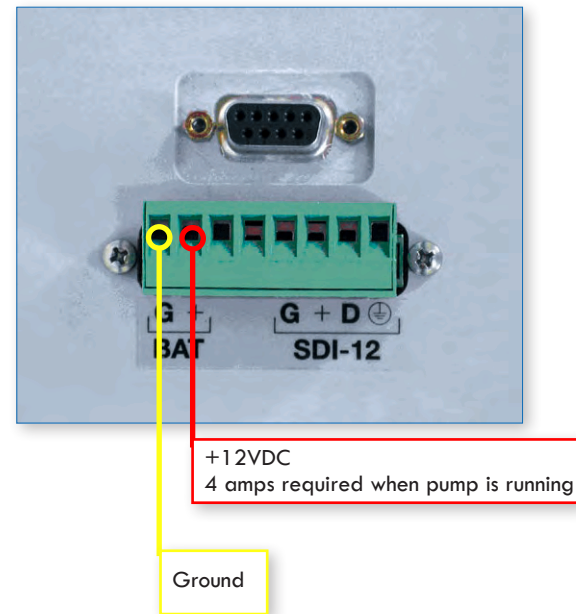

CONSTANT FLOW BUBBLER/RECORDER

STEP 8  
TEST FOR AIR LEAKS & PURGE THE ORIFICE LINE

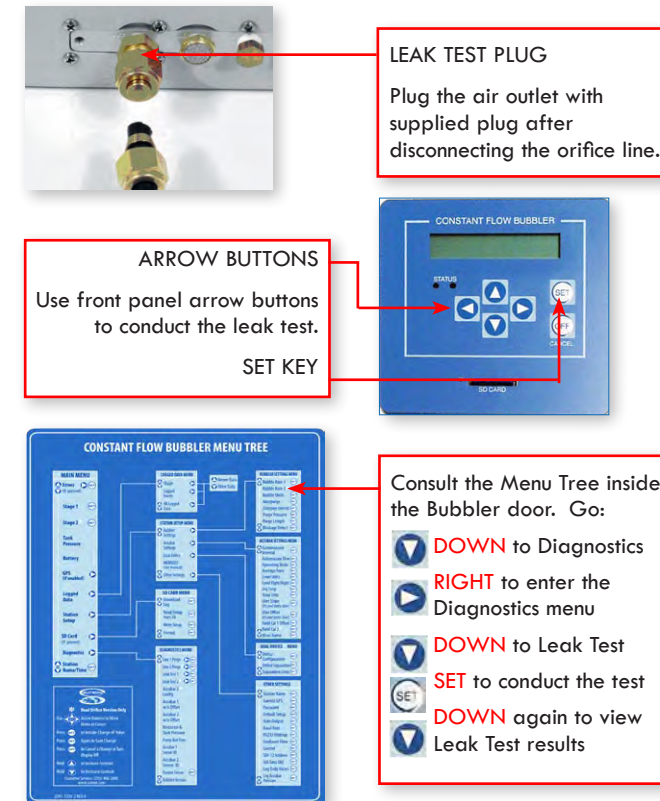

CONSTANT FLOW BUBBLER/RECORDER

STEP 9  
RECONNECT THE ORIFICE LINE & PURGE IT

Purging clears sediment and obstructions from the orifice line. The bubbler builds pressure to a user settable value (default 50 PSI) and then opens the restrictor bypass valve to force the air out the line. The pump will continue to run for a user set period (default 30 seconds) and then turn off.

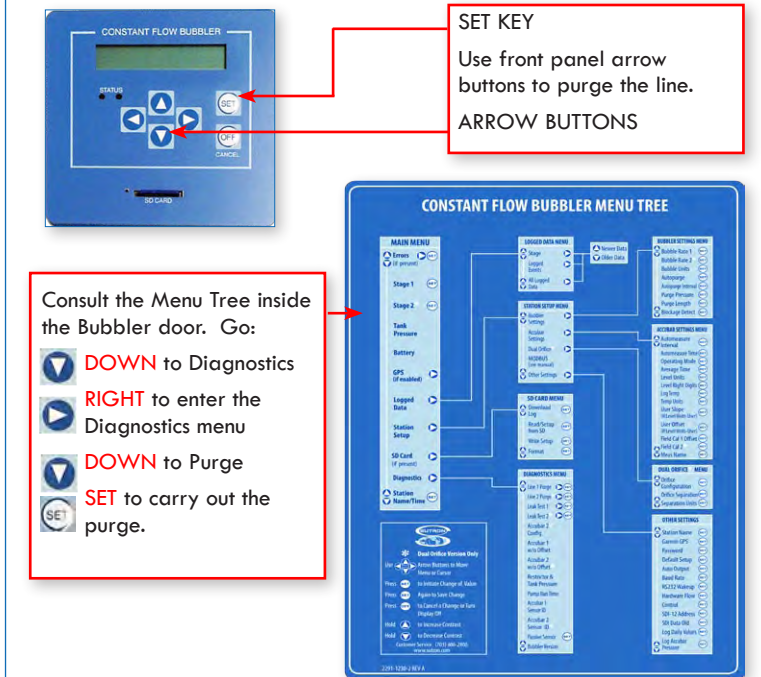

CONSTANT FLOW BUBBLER/RECORDER

STEP 10  
SYNCHRONIZE THE BUBBLER READING WITH YOUR STAFF GAGE

When the Bubbler is first installed, it will display a water level based on the water pressure at the end of the orifice line. You will normally change this reading to match the level on a staff gage.

To set the water level, first make sure the Bubbler is displaying water level.



Then, turn the power off momentarily, or press SET. Enter the correct water level using the buttons as shown below. Then press SET again.

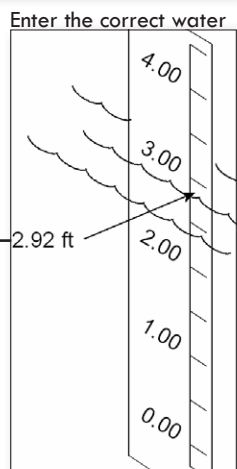

Use UP/DOWN arrow keys to change value at flashing cursor

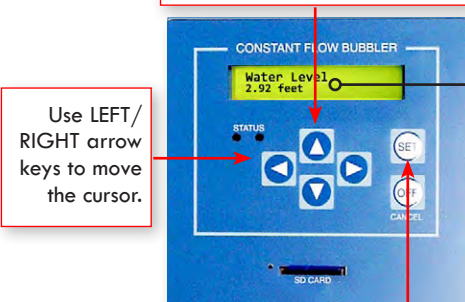

Use LEFT/RIGHT arrow keys to move the cursor.

Use SET key to start & end the synchronization process

CONSTANT FLOW BUBBLER/RECORDER

STEP 11  
CONNECT THE BUBBLER TO THE SATLINK

This is a simple 3-wire connection as shown here:

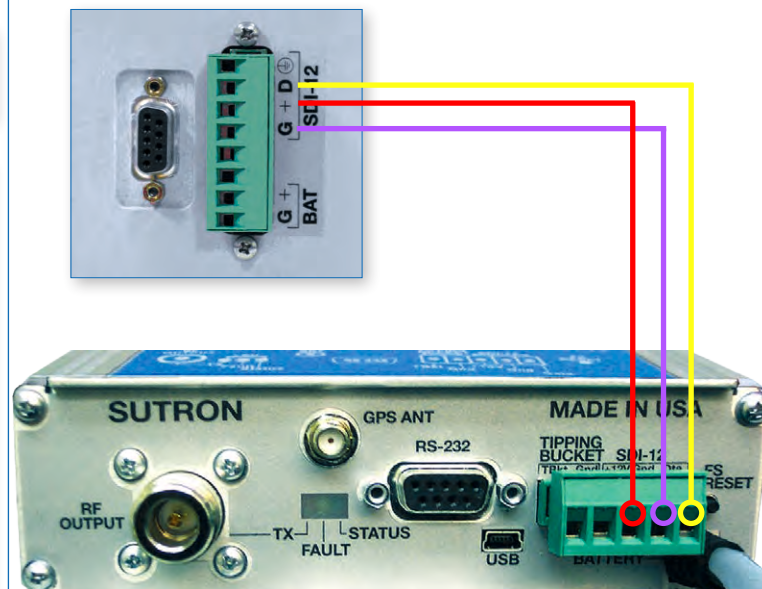

CONSTANT FLOW BUBBLER/RECORDER

STEP 12  
SET UP THE SATLINK MEASUREMENT

Connect your laptop computer to the SatLink and run SatLink Communicator. Proceed to Setup and go to the Measurements tab, as shown below.

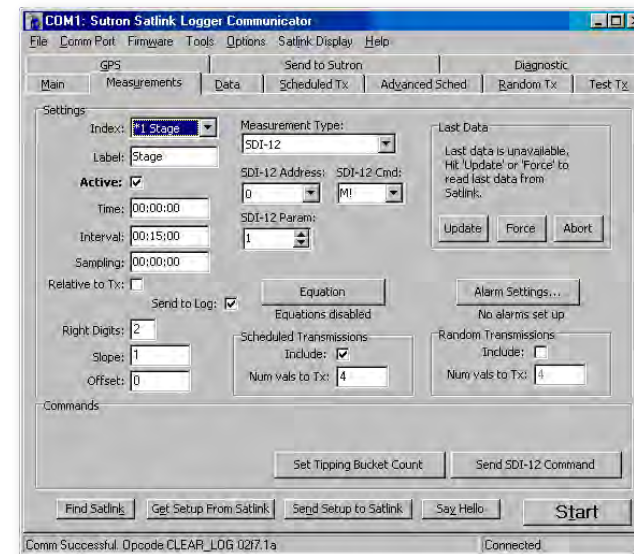

CONSTANT FLOW BUBBLER/RECORDER

STEP 13  
SYNCHRONIZE THE BUBBLER TIME WITH THE SATLINK TIME

The time will synchronize automatically. No action is required on the user's part.

